

KATALOG



SKRÓCONY KATALOG POGLĄDOWY

Dostarczamy wiele innych wykonań na zapytanie klienta!!!

P.P.H.U. Trans-West GmbH Sp. z o. o.

ul. Prądyńskiego 20, 63-000 Środa Wielkopolska

tel. (0-61) 287-02-64, tel/fax (0-61) 285-26-63

e-mail: transwest@telvinet.pl www.transwest.pl

Spis treści

Złącza wtykowe



6 – 15

Zawory sterowane ręcznie



16 – 17

Zawory sterujące przepływem



18 – 19

Zawory kulowe



20 – 21

Zawory zwrotne



22 – 23

Złącza wtykowe odcinające



24 – 25

Pistolety powietrzne



26

Złącza obrotowe



27 – 28

Kolektory przyłączeniowe



29 – 31

Tłumiki



32

Przewody standardowe i spiralne



33 – 34

ZŁĄCZA WTYKOWE STANDARDOWE

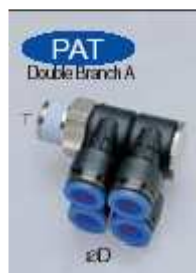

strona 8



strona 8



strona 8



strona 9



strona 9



strona 9



strona 9



strona 10

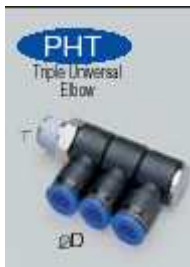

strona 10



strona 10



strona 10



strona 11



strona 11



strona 11

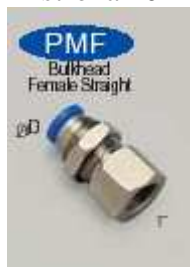

strona 12



strona 12



strona 12



strona 13



strona 13



strona 13



strona 13



strona 14



strona 14



strona 14



strona 14



strona 15



strona 15



strona 15



strona 15

ZŁĄCZA WTYKOWE Z USZCZELKĄ NBR (O-RING)



strona 15



strona 16



strona 16



strona 16



strona 16

ZAWORY STEROWANE RĘCZNIE



strona 18



strona 18

ZAWORY STERUJĄCE PRZEPLYWEM



strona 20



strona 20



strona 20

ZAWORY KULOWE seria 20 & 60



strona 22



strona 22



strona 22



strona 22

ZAWORY ZWROTNE



strona 24



strona 24



strona 24

ZŁĄCZA WTYKOWE ODCINAJĄCE



strona 26



strona 26

PISTOLETY POWIETRZNE



strona 27



strona 27

ZŁĄCZA OBROTOWE



strona 29



strona 29



strona 29



strona 29

KOLEKTORY PRZYŁĄCZENIOWE



strona 31



strona 31



strona 31



strona 31



strona 32



strona 32



strona 32

TŁUMIKI



strona 33

PRZEWODY STANDARDOWE I SPIRALNE



strona 35



strona 35

Złącza wtykowe

Symbolika

MODEL – PRZEWÓD – PRZYŁĄCZE

Przewód [ØD]

04	06	08	10	12	16
Ø4	Ø6	Ø8	Ø10	Ø12	Ø16

Przyłącze [T]

M5	M6	01	02	03	04
M5 x 0.8	M6 x 1.0	1/8	1/4	3/8	1/2

Medium	powietrze (nie stosować z innymi gazami czy cieczami)
Ciśnienie robocze	0 ~ 9 bar
Podciśnienie	-0,95 bar
Zakres temperatur	0-60° C
Możliwe przewody do zastosowania	Poliuretan (PUH) i Poliamid (PA)

Właściwości

- funkcjonalnie zaprojektowane złącza wtykowe ułatwiają szybkie połączenie z przewodem jednym ruchem
- eliptyczna obudowa jest idealnym rozwiązaniem do pneumatycznych instalacji w ograniczonej przestrzeni
- lekki ręczny nacisk na eliptyczną obudowę powoduje szybkie rozłączenie z przewodem
- niklowana obudowa zapewnia skuteczną ochronę przed korozją i zanieczyszczeniem
- gwint z uszczelnieniem teflonowym nie wymaga dodatkowej uszczelki
- duży wybór rozwiązań i pełna gama rozmiarów

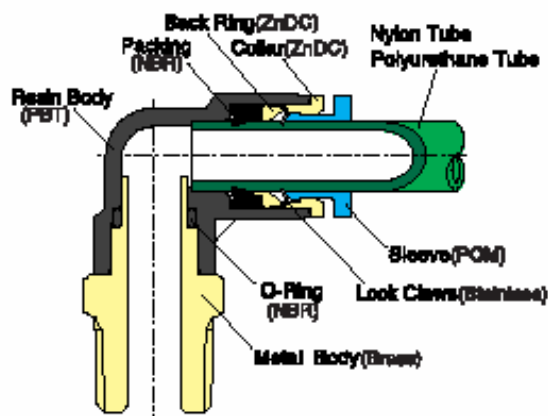

Złącze ustawne kątowe – gwint zewnętrzny

- gwint stożkowy z uszczelnieniem teflonowym
- konstrukcja blokowana po umocowaniu

PAT (2)



ØD - T
PAT-04-01 (2)
PAT-04-02 (2)
PAT-04-03 (2)
PAT-06-01 (2)
PAT-06-02 (2)
PAT-06-03 (2)
PAT-08-01 (2)
PAT-08-02 (2)
PAT-08-03 (2)
PAT-08-04 (2)

ØD - T
PAT-10-02 (2)
PAT-10-03 (2)
PAT-10-04 (2)
PAT-12-02 (2)
PAT-12-03 (2)
PAT-12-04 (2)

Banjo podwójne - gwint wewnętrzny

- konstrukcja blokowana po umocowaniu

PAF



ØD - T
PAF-04-M5
PAF-06-01
PAF-08-02
PAF-10-03
PAF-12-04

Złącze wtykowe proste – gwint zewnętrzny

- gwint stożkowy z uszczelnieniem teflonowym lub z O-ringiem

PC



ØD - T
PC-04-M5
PC-04-M6
PC-04-01
PC-04-02
PC-04-03
PC-06-M5
PC-06-M6
PC-06-01
PC-06-02
PC-06-03
PC-08-01
PC-08-02
PC-08-03
PC-08-04

ØD - T
PC-10-01
PC-10-02
PC-10-03
PC-10-04
PC-12-01
PC-12-02
PC-12-03
PC-12-04
PC-16-03
PC-16-04

Redukcja na przewód

PG 	$\text{ØD}_1 - \text{ØD}_2$
	PG-06-04
	PG-08-04
	PG-08-06
	PG-10-06
	PG-10-08
	PG-12-08
	PG-12-10
	PG-16-12

Redukcja dla przewodu na złączkę

PGJ 	$\text{ØD}_1 - \text{ØD}_2$
	PGJ-06-04
	PGJ-08-04
	PGJ-08-06
	PGJ-10-06
	PGJ-10-08
	PGJ-12-06
	PGJ-12-08
	PGJ-12-10

Banjo pojedyncze – gwint zewnętrzny

- gwint stożkowy z uszczelnieniem teflonowym
- konstrukcja blokowana po umocowaniu

PH 	$\text{ØD} - T$	$\text{ØD} - T$
	PH-04-M5	PH-10-02
	PH-04-M6	PH-10-03
	PH-04-01	PH-10-04
	PH-06-M5	PH-12-02
	PH-06-M6	PH-12-03
	PH-06-01	PH-12-04
	PH-06-02	
	PH-06-03	
	PH-08-01	
	PH-08-02	
	PH-08-03	
	PH-08-04	

Banjo pojedyncze - gwint wewnętrzny

- konstrukcja blokowana po umocowaniu

PHF 	$\text{ØD} - T$	$\text{ØD} - T$
	PHF-04-M5	PHF-08-01
	PHF-04-M6	PHF-08-02
	PHF-04-01	PHF-08-03
	PHF-06-M5	PHF-10-02
	PHF-06-M6	PHF-10-03
	PHF-06-01	PHF-12-03
	PHF-06-02	PHF-12-04

Banjo podwójne dla przewodów – gwint zewnętrzny

- gwint stożkowy z uszczelnieniem teflonowym
- konstrukcja blokowana po umocowaniu

<p>PHT(2)</p> 		<table border="1" style="width: 100%; border-collapse: collapse;"> <thead> <tr> <th>ØD - T</th> </tr> </thead> <tbody> <tr><td>PHT-04-01 (2)</td></tr> <tr><td>PHT-04-02 (2)</td></tr> <tr><td>PHT-04-03 (2)</td></tr> <tr><td>PHT-06-01 (2)</td></tr> <tr><td>PHT-06-02 (2)</td></tr> <tr><td>PHT-06-03 (2)</td></tr> <tr><td>PHT-08-01 (2)</td></tr> <tr><td>PHT-08-02 (2)</td></tr> <tr><td>PHT-08-03 (2)</td></tr> <tr><td>PHT-08-04 (2)</td></tr> </tbody> </table>	ØD - T	PHT-04-01 (2)	PHT-04-02 (2)	PHT-04-03 (2)	PHT-06-01 (2)	PHT-06-02 (2)	PHT-06-03 (2)	PHT-08-01 (2)	PHT-08-02 (2)	PHT-08-03 (2)	PHT-08-04 (2)
ØD - T													
PHT-04-01 (2)													
PHT-04-02 (2)													
PHT-04-03 (2)													
PHT-06-01 (2)													
PHT-06-02 (2)													
PHT-06-03 (2)													
PHT-08-01 (2)													
PHT-08-02 (2)													
PHT-08-03 (2)													
PHT-08-04 (2)													
		<table border="1" style="width: 100%; border-collapse: collapse;"> <thead> <tr> <th>ØD - T</th> </tr> </thead> <tbody> <tr><td>PHT-10-02 (2)</td></tr> <tr><td>PHT-10-03 (2)</td></tr> <tr><td>PHT-10-04 (2)</td></tr> <tr><td>PHT-12-02 (2)</td></tr> <tr><td>PHT-12-03 (2)</td></tr> <tr><td>PHT-12-04 (2)</td></tr> </tbody> </table>	ØD - T	PHT-10-02 (2)	PHT-10-03 (2)	PHT-10-04 (2)	PHT-12-02 (2)	PHT-12-03 (2)	PHT-12-04 (2)				
ØD - T													
PHT-10-02 (2)													
PHT-10-03 (2)													
PHT-10-04 (2)													
PHT-12-02 (2)													
PHT-12-03 (2)													
PHT-12-04 (2)													

Banjo potrójne dla przewodów – gwint zewnętrzny

- gwint stożkowy z uszczelnieniem teflonowym
- konstrukcja blokowana po umocowaniu

<p>PHT(3)</p> 		<table border="1" style="width: 100%; border-collapse: collapse;"> <thead> <tr> <th>ØD - T</th> </tr> </thead> <tbody> <tr><td>PHT-04-01 (3)</td></tr> <tr><td>PHT-04-02 (3)</td></tr> <tr><td>PHT-04-03 (3)</td></tr> <tr><td>PHT-06-01 (3)</td></tr> <tr><td>PHT-06-02 (3)</td></tr> <tr><td>PHT-06-03 (3)</td></tr> <tr><td>PHT-08-01 (3)</td></tr> <tr><td>PHT-08-02 (3)</td></tr> <tr><td>PHT-08-03 (3)</td></tr> </tbody> </table>	ØD - T	PHT-04-01 (3)	PHT-04-02 (3)	PHT-04-03 (3)	PHT-06-01 (3)	PHT-06-02 (3)	PHT-06-03 (3)	PHT-08-01 (3)	PHT-08-02 (3)	PHT-08-03 (3)
ØD - T												
PHT-04-01 (3)												
PHT-04-02 (3)												
PHT-04-03 (3)												
PHT-06-01 (3)												
PHT-06-02 (3)												
PHT-06-03 (3)												
PHT-08-01 (3)												
PHT-08-02 (3)												
PHT-08-03 (3)												
		<table border="1" style="width: 100%; border-collapse: collapse;"> <thead> <tr> <th>ØD - T</th> </tr> </thead> <tbody> <tr><td>PHT-10-02 (3)</td></tr> <tr><td>PHT-10-03 (3)</td></tr> <tr><td>PHT-10-04 (3)</td></tr> <tr><td>PHT-12-02 (3)</td></tr> <tr><td>PHT-12-03 (3)</td></tr> <tr><td>PHT-12-04 (3)</td></tr> </tbody> </table>	ØD - T	PHT-10-02 (3)	PHT-10-03 (3)	PHT-10-04 (3)	PHT-12-02 (3)	PHT-12-03 (3)	PHT-12-04 (3)			
ØD - T												
PHT-10-02 (3)												
PHT-10-03 (3)												
PHT-10-04 (3)												
PHT-12-02 (3)												
PHT-12-03 (3)												
PHT-12-04 (3)												

Redukcja prosta na złącze przewodowe

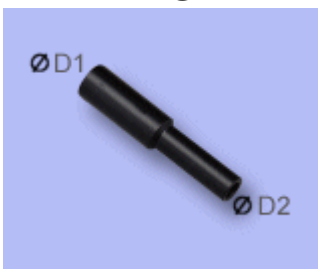
<p>PIG</p> 		<table border="1" style="width: 100%; border-collapse: collapse;"> <thead> <tr> <th>ØD₁ – ØD₂</th> </tr> </thead> <tbody> <tr><td>PIG-06-04</td></tr> <tr><td>PIG-08-04</td></tr> <tr><td>PIG-08-06</td></tr> <tr><td>PIG-10-06</td></tr> <tr><td>PIG-10-08</td></tr> <tr><td>PIG-12-08</td></tr> <tr><td>PIG-12-10</td></tr> <tr><td>PIG-16-12</td></tr> </tbody> </table>	ØD ₁ – ØD ₂	PIG-06-04	PIG-08-04	PIG-08-06	PIG-10-06	PIG-10-08	PIG-12-08	PIG-12-10	PIG-16-12
ØD ₁ – ØD ₂											
PIG-06-04											
PIG-08-04											
PIG-08-06											
PIG-10-06											
PIG-10-08											
PIG-12-08											
PIG-12-10											
PIG-16-12											

Złącze wielowtykowe wkręcane

- gwint stożkowy z uszczelnieniem teflonowym

<p>PKD</p> 		<table border="1" style="width: 100%; border-collapse: collapse;"> <thead> <tr> <th>ØD₁ – ØD₂ - T</th> </tr> </thead> <tbody> <tr><td>PKD-06-04-01</td></tr> <tr><td>PKD-08-04-02</td></tr> <tr><td>PKD-08-06-02</td></tr> <tr><td>PKD-10-08-03</td></tr> </tbody> </table>	ØD ₁ – ØD ₂ - T	PKD-06-04-01	PKD-08-04-02	PKD-08-06-02	PKD-10-08-03
ØD ₁ – ØD ₂ - T							
PKD-06-04-01							
PKD-08-04-02							
PKD-08-06-02							
PKD-10-08-03							

Złącze wielowytkowe

PKG



ØD ₁ – ØD ₂
PKG-06-04
PKG-08-04
PKG-08-06
PKG-10-06
PKG-10-08

Złącze wtykowe kątowe wkręcane

- gwint stożkowy z uszczelnieniem teflonowym
- ustawienie pod dowolnym kątem

PL



ØD - T	ØD - T
PL-04-M5	PL-10-01
PL-04-M6	PL-10-02
PL-04-01	PL-10-03
PL-04-02	PL-10-04
PL-04-03	PL-12-01
PL-06-M5	PL-12-02
PL-06-M6	PL-12-03
PL-06-01	PL-12-04
PL-06-02	PL-16-03
PL-06-03	PL-16-04
PL-08-01	
PL-08-02	
PL-08-03	
PL-08-04	

Złącze wtykowe kątowe

PLJ



ØD
PLJ-04
PLJ-06
PLJ-08
PLJ-10
PLJ-12
PLJ-16

Złącze wtykowe grodziowe proste – gwint wewnętrzny

- gwint walcowy z uszczelnieniem teflonowym

PMF



ØD - T	ØD - T
PMF-04-01	PMF-10-01
PMF-04-02	PMF-10-02
PMF-04-03	PMF-10-03
PMF-06-01	PMF-10-04
PMF-06-02	PMF-12-01
PMF-06-03	PMF-12-02
PMF-08-01	PMF-12-03
PMF-08-02	PMF-12-04
PMF-08-03	
PMF-08-04	

Złącze wtykowe grodziowe proste

PPM



ØD
PPM-04
PPM-06
PPM-08
PPM-10
PPM-12

Trójnik wkręcany

- gwint stożkowy z uszczelnieniem teflonowym
- konstrukcja blokowana po umocowaniu

PST



ØD - T	ØD - T
PST-04-M5	PST-10-01
PST-04-M6	PST-10-02
PST-04-01	PST-10-03
PST-04-02	PST-10-04
PST-04-03	PST-12-01
PST-06-M5	PST-12-02
PST-06-M6	PST-12-03
PST-06-01	PST-12-04
PST-06-02	
PST-06-03	
PST-08-01	
PST-08-02	
PST-08-03	
PST-08-04	

Trójnik wkręcany

- gwint stożkowy z uszczelnieniem teflonowym
- ustawienie pod dowolnym kątem

PT



ØD - T	ØD - T
PT-04-M5	PT-10-01
PT-04-M6	PT-10-02
PT-04-01	PT-10-03
PT-04-02	PT-10-04
PT-04-03	PT-12-01
PT-06-M5	PT-12-02
PT-06-M6	PT-12-03
PT-06-01	PT-12-04
PT-06-02	PT-16-03
PT-06-03	PT-16-04
PT-08-01	
PT-08-02	
PT-08-03	
PT-08-04	

Złącze wtykowe proste na przewód

PUC



ØD
PUC 04
PUC 06
PUC 08
PUC 10
PUC 12
PUC 16

Złącze wtykowe typu trójnik na dwie średnice przewodów

PUG



ØD ₁ – ØD ₂
PUG-06-04
PUG-08-04
PUG-08-06
PUG-10-06
PUG-10-08
PUG-12-08
PUG-12-10

Złącze wtykowe kątowe na przewód

PUL



ØD
PUL 04
PUL 06
PUL 08
PUL 10
PUL 12
PUL 16

Trójnik

PUT



ØD
PUT 04
PUT 06
PUT 08
PUT 10
PUT 12
PUT 16

Redukcja typu Y na przewód

<p>PW</p>  <p>ØD1 ØD2</p>		<table border="1" style="margin: auto;"> <tr><td>ØD₁ – ØD₂</td></tr> <tr><td>PW-06-04</td></tr> <tr><td>PW-08-04</td></tr> <tr><td>PW-08-06</td></tr> <tr><td>PW-10-06</td></tr> <tr><td>PW-10-08</td></tr> <tr><td>PW-12-08</td></tr> <tr><td>PW-12-10</td></tr> <tr><td>PW-16-12</td></tr> </table>	ØD ₁ – ØD ₂	PW-06-04	PW-08-04	PW-08-06	PW-10-06	PW-10-08	PW-12-08	PW-12-10	PW-16-12
ØD ₁ – ØD ₂											
PW-06-04											
PW-08-04											
PW-08-06											
PW-10-06											
PW-10-08											
PW-12-08											
PW-12-10											
PW-16-12											

Złącze wtykowe typu Y

<p>PWJ</p>  <p>ØD2 ØD1</p>	<table border="1" style="margin: auto;"> <tr><td>ØD₁ – ØD₂</td></tr> <tr><td>PWJ-06-04</td></tr> <tr><td>PWJ-08-06</td></tr> <tr><td>PWJ-10-08</td></tr> <tr><td>PWJ-12-10</td></tr> </table>	ØD ₁ – ØD ₂	PWJ-06-04	PWJ-08-06	PWJ-10-08	PWJ-12-10
ØD ₁ – ØD ₂						
PWJ-06-04						
PWJ-08-06						
PWJ-10-08						
PWJ-12-10						

Złącze wtykowe typu Y – gwint zewnętrzny

- gwint stożkowy z uszczelnieniem teflonowym
- ustawienie pod dowolnym kątem

<p>PWT</p>  <p>ØD T</p>	<table border="1" style="margin: auto;"> <tr><td>ØD - T</td></tr> <tr><td>PWT-04-M5</td></tr> <tr><td>PWT-04-M6</td></tr> <tr><td>PWT-04-01</td></tr> <tr><td>PWT-04-02</td></tr> <tr><td>PWT-04-03</td></tr> <tr><td>PWT-06-M5</td></tr> <tr><td>PWT-06-M6</td></tr> <tr><td>PWT-06-01</td></tr> <tr><td>PWT-06-02</td></tr> <tr><td>PWT-06-03</td></tr> <tr><td>PWT-08-01</td></tr> <tr><td>PWT-08-02</td></tr> <tr><td>PWT-08-03</td></tr> <tr><td>PWT-08-04</td></tr> </table>	ØD - T	PWT-04-M5	PWT-04-M6	PWT-04-01	PWT-04-02	PWT-04-03	PWT-06-M5	PWT-06-M6	PWT-06-01	PWT-06-02	PWT-06-03	PWT-08-01	PWT-08-02	PWT-08-03	PWT-08-04	<table border="1" style="margin: auto;"> <tr><td>ØD - T</td></tr> <tr><td>PWT-10-01</td></tr> <tr><td>PWT 10-02</td></tr> <tr><td>PWT 10-03</td></tr> <tr><td>PWT-10-04</td></tr> <tr><td>PWT-12-01</td></tr> <tr><td>PWT-12-02</td></tr> <tr><td>PWT 12-03</td></tr> <tr><td>PWT 12-04</td></tr> </table>	ØD - T	PWT-10-01	PWT 10-02	PWT 10-03	PWT-10-04	PWT-12-01	PWT-12-02	PWT 12-03	PWT 12-04
ØD - T																										
PWT-04-M5																										
PWT-04-M6																										
PWT-04-01																										
PWT-04-02																										
PWT-04-03																										
PWT-06-M5																										
PWT-06-M6																										
PWT-06-01																										
PWT-06-02																										
PWT-06-03																										
PWT-08-01																										
PWT-08-02																										
PWT-08-03																										
PWT-08-04																										
ØD - T																										
PWT-10-01																										
PWT 10-02																										
PWT 10-03																										
PWT-10-04																										
PWT-12-01																										
PWT-12-02																										
PWT 12-03																										
PWT 12-04																										

Redukcja podwójna typu Y na przewód

<p>PXG</p>  <p>ØD1 ØD2</p>	<table border="1" style="margin: auto;"> <tr><td>ØD₁ – ØD₂</td></tr> <tr><td>PXG 06-04</td></tr> <tr><td>PXG 08-06</td></tr> </table>	ØD ₁ – ØD ₂	PXG 06-04	PXG 08-06
ØD ₁ – ØD ₂				
PXG 06-04				
PXG 08-06				

Redukcja podwójna typu Y

PXJ

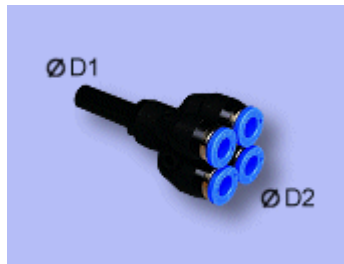

$\text{ØD}_1 - \text{ØD}_2$
PXJ 06-04
PXJ 08-06

Trójnik typu Y na przewód

PY



ØD
PY 04
PY 06
PY 08
PY 10
PY 12
PY 16

Czwórnik wtykowy na przewody

PZA



ØD
PZA 04
PZA 06
PZA 08
PZA 10
PZA 12

Złącze wtykowe proste – gwint zewnętrzny

- gwint walcowy z uszczelką NBR (O-ring)

PC-G



$\text{ØD} - T$
PC-04-G-01
PC-04-G-02
PC-04-G-03
PC-06-G-01
PC-06-G-02
PC-06-G-03
PC-08-G-01
PC-08-G-02
PC-08-G-03

$\text{ØD} - T$
PC-10-G-01
PC-10-G-02
PC-10-G-03
PC-10-G-04
PC-12-G-02
PC-12-G-03
PC-12-G-04
PC-16-G-03
PC-16-G-04

Złącze wtykowe kątowe – gwint zewnętrzny

- gwint walcowy z uszczelką NBR (O-ring)

<p>PL-G</p>  <p style="text-align: center;">T ØD</p>	ØD - T	ØD - T
	PL-04-G-01	PL-10-G-01
	PL-04-G-02	PL-10-G-02
	PL-04-G-03	PL-10-G-03
	PL-06-G-01	PL-10-G-04
	PL-06-G-02	PL-12-G-02
	PL-06-G-03	PL-12-G-03
	PL-08-G-01	PL-12-G-04
	PL-08-G-02	PL-16-G-03
	PL-08-G-03	PL-16-G-04

Trójnik wkręcany

- gwint walcowy z uszczelką NBR (O-ring)

<p>PST-G</p>  <p style="text-align: center;">ØD T</p>	ØD - T	ØD - T
	PST-04-G-01	PST-10-G-01
	PST-04-G-02	PST-10-G-02
	PST-04-G-03	PST-10-G-03
	PST-06-G-01	PST-10-G-04
	PST-06-G-02	PST-12-G-02
	PST-06-G-03	PST-12-G-03
	PST-08-G-01	PST-12-G-04
	PST-08-G-02	PST-16-G-04
	PST-08-G-03	

Trójnik wkręcany

- gwint walcowy z uszczelką NBR (O-ring)

<p>PT-G</p>  <p style="text-align: center;">T ØD</p>	ØD - T	ØD - T
	PT-04-G-01	PT-10-G-01
	PT-04-G-02	PT-10-G-02
	PT-04-G-03	PT-10-G-03
	PT-06-G-01	PT-10-G-04
	PT-06-G-02	PT-12-G-02
	PT-06-G-03	PT-12-G-03
	PT-08-G-01	PT-12-G-04
	PT-08-G-02	PT-16-G-03
	PT-08-G-03	

Złącze wtykowe typu Y – gwint zewnętrzny

- gwint walcowy z uszczelką NBR (O-ring)

<p>PWT-G</p>  <p style="text-align: center;">ØD T</p>	ØD - T	ØD - T
	PWT-04-G-01	PWT-10-G-02
	PWT-04-G-02	PWT-10-G-03
	PWT-04-G-03	PWT-10-G-04
	PWT-06-G-01	PWT-12-G-02
	PWT-06-G-02	PWT-12-G-03
	PWT-06-G-03	PWT-12-G-04
	PWT-08-G-01	
	PWT-08-G-02	
	PWT-08-G-03	

Zawory ręczne i suwakowe

Symbolika

MODEL – PRZEWÓD – PRZYŁĄCZE

Przewód [ØD]

04	06	08	10	12
Ø4	Ø6	Ø8	Ø10	Ø12

Przyłącze [T]

01	02	03	04
1/8	1/4	3/8	1/2

Medium	powietrze (nie stosować z innymi gazami czy cieczeniami)
Ciśnienie robocze	0 ~ 9 bar
Podciśnienie	-0,95 bar
Zakres temperatur	0-60° C
Możliwe przewody do zastosowania	Poliuretan (PUH) i Poliamid (PA)

Właściwości

- służą do ręcznego odcięcia zasilania
- przy zamknięciu zaworu 3-drogowego następuje odcięcie zasilania i odpowietrzenie odbiorników
- zawór ręczny jest przydatny w celach kontrolnych i diagnostycznych urządzeń pneumatycznych

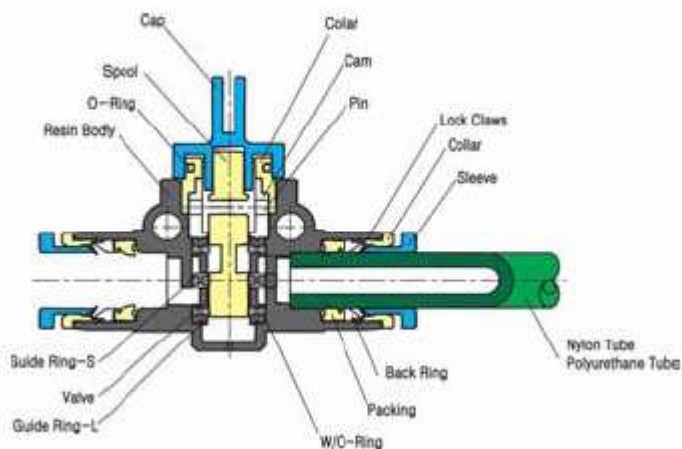

Zawór ręczny

- gwint walcowy z uszczelką NBR (O-ring)

HVFS-G



ØD - T

HVFS-06-G-01

HVFS-06-G-02

HVFS-06-G-03

HVFS-08-G-01

HVFS-08-G-02

HVFS-08-G-03

ØD - T

HVFS-10-G-02

HVFS-10-G-03

HVFS-10-G-04

HVFS-12-G-02

HVFS-12-G-03

HVFS-12-G-04

Zawór suwakowy

- cechuje się dużą żywotnością

HSV-M



ØD - T

HSV-M-M5

HSV-M-1/8

HSV-M-1/4

HSV-M-3/8

HSV-M-1/2

HSV-M-3/4

Zawory sterujące przepływem

Symbolika

MODEL – PRZEWÓD – PRZYŁĄCZE - KIERUNEK PRZEPŁYWU

Przewód [ØD]

04	06	08	10	12	16
Ø4	Ø6	Ø8	Ø10	Ø12	Ø16

Przyłącze [T]

M5	M6	01	02	03	04
M5 x 0.8	M6 x 1.0	1/8	1/4	3/8	1/2

Kierunek przepływu [OUT – IN]

OUT	IN
niebieski	czerwony

Medium	powietrze (nie stosować z innymi gazami czy cieczami)
Ciśnienie robocze	0 ~ 9 bar
Podciśnienie	- 0,5 bar
Zakres temperatur	0-60° C
Możliwe przewody do zastosowania	Poliuretan (PUH) i Poliamid (PA)

Właściwości

- dokładnie regulują prędkość przepływu powietrza dla precyzyjnego ruchu siłownika
- wyróżniają się zwartością konstrukcji – małe wymiary
- zależnie od typu umożliwiają realizację dławienia w dopływie lub wypływie

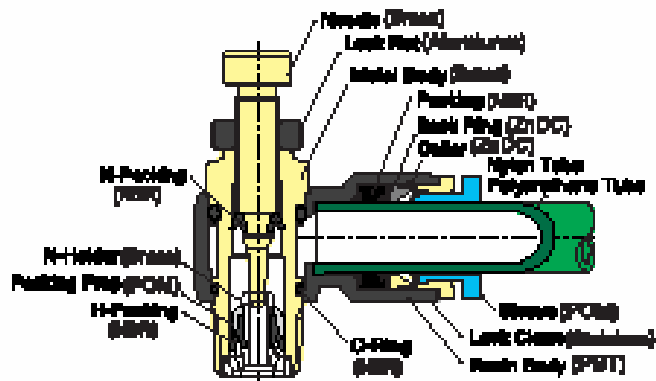

Zawór sterujący przepływem – kolanko

- gwint stożkowy z uszczelnieniem teflonowym

<p>NSE</p> 	ØD - T		ØD - T
	NSE-04-M5 OUT		NSE-04-M5 IN
	NSE-04-01 OUT		NSE-04-01 IN
	NSE-04-02 OUT		NSE-04-02 IN
	NSE-06-M5 OUT		NSE-06-M5 IN
	NSE-06-01 OUT		NSE-06-01 IN
	NSE-06-02 OUT		NSE-06-02 IN
	NSE-06-03 OUT		NSE-06-03 IN
	NSE-08-01 OUT		NSE-08-01 IN
	NSE-08-02 OUT		NSE-08-02 IN
	NSE-08-03 OUT		NSE-08-03 IN
	NSE-08-04 OUT		NSE-08-04 IN
	NSE-10-02 OUT		NSE-10-02 IN
	NSE-10-03 OUT		NSE-10-03 IN
	NSE-10-04 OUT		NSE-10-04 IN
	NSE-12-02 OUT		NSE-12-02 IN
NSE-12-03 OUT		NSE-12-03 IN	
NSE-12-04 OUT		NSE-12-04 IN	

Zawór sterujący przepływem – kolanko

- gwint walcowy z uszczelką NBR (O-ring)

<p>NSE-G</p> 	ØD - T		ØD - T
	NSE-04-G-01 OUT		NSE-04-G-01 IN
	NSE-04-G-02 OUT		NSE-04-G-02 IN
	NSE-06-G-01 OUT		NSE-06-G-01 IN
	NSE-06-G-02 OUT		NSE-06-G-02 IN
	NSE-06-G-03 OUT		NSE-06-G-03 IN
	NSE-08-G-01 OUT		NSE-08-G-01 IN
	NSE-08-G-02 OUT		NSE-08-G-02 IN
	NSE-08-G-03 OUT		NSE-08-G-03 IN
	NSE-08-G-04 OUT		NSE-08-G-04 IN
	NSE-10-G-02 OUT		NSE-10-G-02 IN
	NSE-10-G-03 OUT		NSE-10-G-03 IN
	NSE-10-G-04 OUT		NSE-10-G-04 IN
	NSE-12-G-03 OUT		NSE-12-G-03 IN
	NSE-12-G-04 OUT		NSE-12-G-04 IN

Zawór sterujący przepływem – przelotowy

- dwustronnie wtykowy na przewód

<p>NSF</p> 	ØD
	NSF-04
	NSF-06
	NSF-08
	NSF-10
	NSF-12

Zawory kulowe

Symbolika

MODEL – SERIA - PRZEWÓD – PRZYŁĄCZE

Seria

	20	60
Wielkość	20 mm ²	60 mm ²

Przewód [ØD]

04	06	08	10	12
Ø4	Ø6	Ø8	Ø10	Ø12

Przyłącze [T]

01	02	03	04
1/8	1/4	3/8	1/2

Medium	powietrze & woda
Ciśnienie robocze	0 ~ 9 bar
Podciśnienie	-0,95 bar
Zakres temperatur	0-60° C
Możliwe przewody do zastosowania	Poliuretan (PUH) i Poliamid (PA)

Właściwości

- zawory kulowe umożliwiają zamykanie i otwieranie przepływu
- możliwa praca zarówno z powietrzem jak i wodą
- gabaryty zaworu dopasowane do średnicy przewodów łączących
- specjalnie zaprojektowany uchwyt umożliwia łatwe ustawienie w pozycji otwartej i zamkniętej

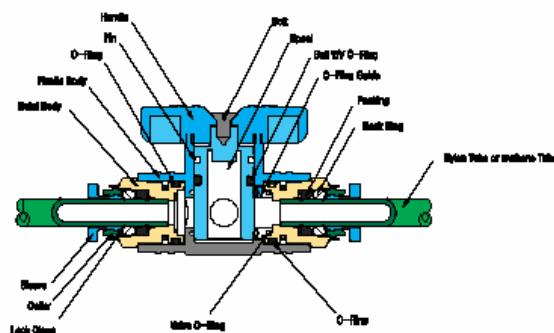

Zawór kulowy prosty – gwint zewnętrzny

- gwint walcowy z uszczelką NBR (O-ring)



ØD - T
BC-20-06-G-01
BC-20-06-G-02
BC-20-06-G-03
BC-20-08-G-01
BC-20-08-G-02
BC-20-08-G-03

ØD - T
BC-60-10-G-02
BC-60-10-G-03
BC-60-10-G-04
BC-60-12-G-02
BC-60-12-G-03
BC-60-12-G-04

Zawór kulowy prosty

- zawór z dwustronnymi wtykami na przewód

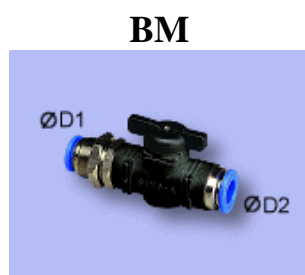

ØD - T
BM-20-06-06
BM-20-08-06
BM-20-08-08
BM-60-10-10
BM-60-12-10
BM-60-12-12

Zawór kulowy kątowy – gwint zewnętrzny

- gwint stożkowy z uszczelnieniem teflonowym

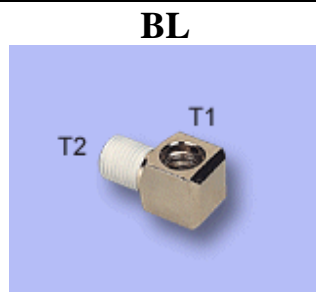

ØD - T
BL-20-06-02
BL-20-06-03
BL-20-06-04
BL-20-08-02
BL-20-08-03
BL-20-08-04

ØD - T
BL-60-10-02
BL-60-10-03
BL-60-10-04
BL-60-12-02
BL-60-12-03
BL-60-12-04

Zawór kulowy prosty

- zawór z dwustronnymi wtykami na przewód o różnych średnicach



ØD ₁ – ØD ₂
BUC-20-06-06
BUC-20-08-08
BUG-20-08-06

ØD ₁ – ØD ₂
BUC-60-10-10
BUC-60-12-12
BUG-60-12-10

Zawory zwrotne

Symbolika

MODEL – PRZEWÓD – PRZYŁĄCZE

Przewód [ØD]

04	06	08	10	12
Ø4	Ø6	Ø8	Ø10	Ø12

Przyłącze [T]

M5	M6	01	02	03	04
M5 x 0.8	M6 x 1.0	1/8	1/4	3/8	1/2



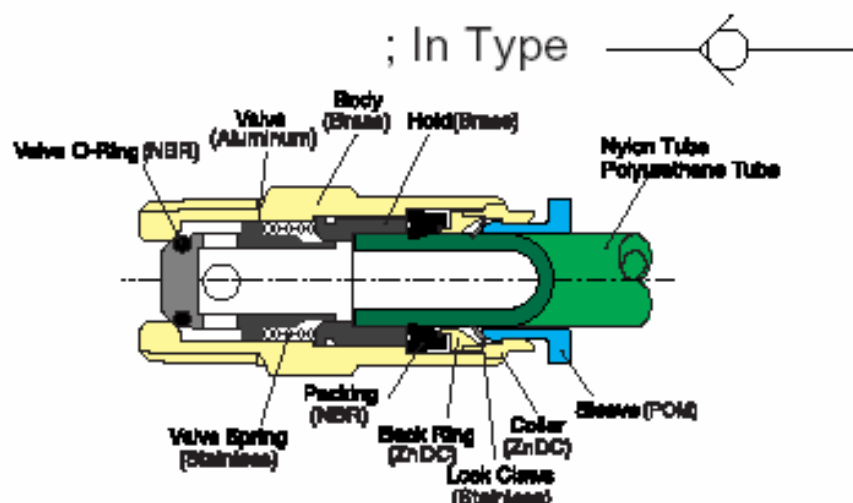

Medium	powietrze (nie stosować z innymi gazami czy cieczami)
Ciśnienie robocze	0 ~ 9 bar
Podciśnienie	-0,95 bar
Zakres temperatur	0-60° C
Możliwe przewody do zastosowania	Poliuretan (PUH) i Poliamid (PA)

Właściwości

- możliwość przepływu powietrza w jednym kierunku
- ciśnienie otwarcia zaworu wynosi 0,1 bar
- zawór może pracować przy podciśnieniu

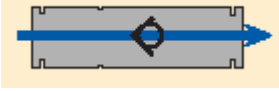

Sposób kontroli

Typ	In	Out
PCVC		
PCVF		
PCVU	 Podłączyć zgodnie ze znakiem wybitym na korpusie	

Zawór zwrotny prosty

- gwint zewnętrzny stożkowy z uszczelnieniem teflonowym oraz gwint wewnętrzny

PCVF



T₁ - T₂

PCVF-01-01

PCVF-02-02

PCVF-03-03

PCVF-04-04

Zawór zwrotny prosty

- gwint stożkowy z uszczelnieniem teflonowym ; OUT

PCVC



ØD - T

PCVC-04-M5

PCVC-04-M6

PCVC-04-01

PCVC-06-01

PCVC-06-02

ØD - T

PCVC-08-01

PCVC-08-02

PCVC-10-03

PCVC-10-04

PCVC-12-03

PCVC-12-04

Zawór zwrotny prosty wtykowy

PCVU



ØD

PCVU-04

PCVU-06

PCVU-08

PCVU-10

PCVU-12

Złącza wtykowe odcinające

Symbolika

MODEL – PRZEWÓD – PRZYŁĄCZE

Przewód [ØD]

04	06	08	10	12
Ø4	Ø6	Ø8	Ø10	Ø12

Przyłącze [T]

M5	M6	01	02	03	04
M5 x 0.8	M6 x 1.0	1/8	1/4	3/8	1/2

Medium	powietrze (nie stosować z innymi gazami czy cieczami)
Ciśnienie robocze	0 ~ 9 bar
Podciśnienie	-0,95 bar
Zakres temperatur	0-60° C
Możliwe przewody do zastosowania	Poliuretan (PUH) i Poliamid (PA)

Właściwości

- otwarcie następuje po wprowadzeniu przewodu
- ochrona ujęcia powietrza po odłączeniu przewodu zapewnia bezpieczeństwo podczas naprawy urządzeń pneumatycznych
- złącza wtykowe odcinające są idealne do demonstracji oraz testowania połączeń pneumatycznych

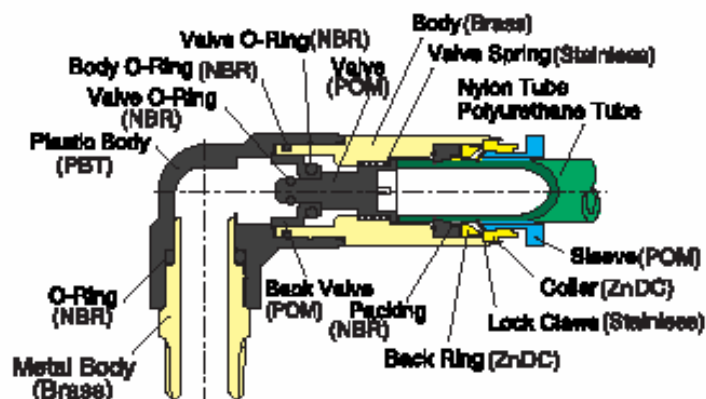

Zawór prosty

- gwint stożkowy z uszczelnieniem teflonowym

SPC

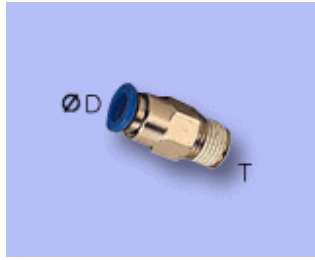

ØD - T

SPC-04-01

SPC-06-01

SPC-06-02

SPC-08-02

SPC-08-03

ØD - T

SPC-10-02

SPC-10-03

SPC-10-04

SPC-12-03

SPC-12-04

Zawór kątowy

- gwint stożkowy z uszczelnieniem teflonowym

SPL



ØD - T

SPL-04-M5

SPL-04-M6

SPL-04-01

SPL-06-M5

SPL 06-01

SPL-06-02

SPL-08-01

SPL-08-02

SPL-08-03

ØD - T

SPL-10-02

SPL-10-03

SPL-10-04

SPL-12-03

SPL-12-04

Pistolety powietrzne

Symbolika

MODEL – PRZEWÓD – PRZYŁĄCZE - DYSZA

Przewód [ØD]

08	10
Ø8	Ø10

Przyłącze [T]

02	03
1/4	3/8

Dysza

S	M
krótka	długa

Medium	powietrze (nie stosować z innymi gazami czy cieczami)
Ciśnienie robocze	0 ~ 9 bar
Zakres temperatur	0-60° C

Właściwości

- dostępne w różnych długościach dyszy
- łatwe regulowanie przepływu powietrza
- ergonomiczne kształty, lekkie
- plastikowa obudowa odporna na uderzenia

Pistolet powietrzny

- do wyboru dysza krótka i średnia

AGS

AGM

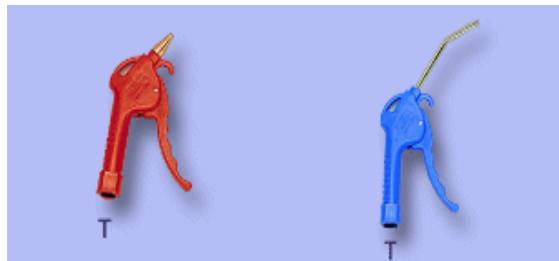

T

AG-08-02-S

AG-10-02-S

AG-10-03-S

T

AG-08-02-M

AG-10-02-M

AG-10-03-M

Złącza obrotowe

Symbolika

MODEL – PRZEWÓD – PRZYŁĄCZE

Przewód [ØD]

04	06	08	10	12
Ø4	Ø6	Ø8	Ø10	Ø12

Przyłącze [T]

M5	M6	01	02	03	04
M5 x 0.8	M6 x 1.0	1/8	1/4	3/8	1/2

Liczba obrotów

Typ	Ø4	Ø6	Ø8	Ø10	Ø12
NRL	500	500	400	300	250
NHRF NHRL	1500	1200	1200	1000	1000

Medium	powietrze (nie stosować z innymi gazami czy cieczami)
Ciśnienie robocze	0 ~ 9 bar
Podciśnienie	-0,95 bar
Zakres temperatur	0-60° C
Możliwe przewody do zastosowania	Poliuretan (PUH) i Poliamid (PA)

Właściwości

- silne ułożyskowanie zespołu umożliwia trwałą pracę przy określonych obrotach oraz wygodę ustawiania zespołu
- zakres prędkości w granicy od 500 do 1500 obrotów na minutę
- złącza obrotowe zwiększają trwałość połączeń, w których występują wibracje i ruchy przewodów

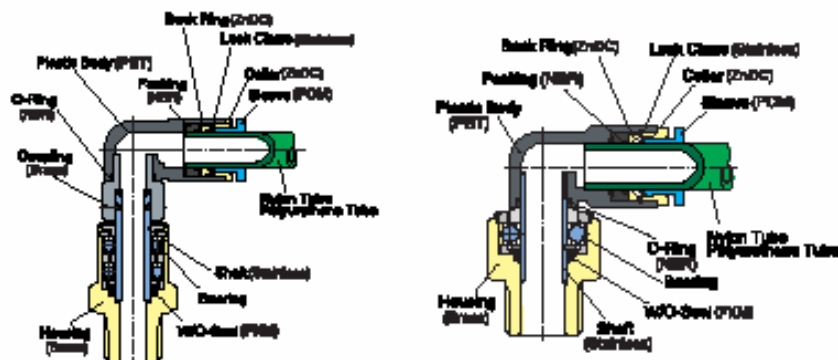

Złącze obrotowe proste

- gwint walcowy z uszczelką NBR (O-ring)

NHRF-G



T ₁ - T ₂
NHRF-G-01-G-01
NHRF-G-01-G-02
NHRF-G-02-G-01
NHRF-G-02-G-02
NHRF-G-03-G-03
NHRF-G-03-G-04
NHRF-G-04-G-03
NHRF-G-04-G-04

Złącze obrotowe kątowe

- gwint walcowy z uszczelką NBR (O-ring)

NHRL-G



ØD - T
NHRL-04-G-01
NHRL-06-G-01
NHRL-06-G-02
NHRL-08-G-01
NHRL-08-G-02

ØD - T
NHRL-10-G-03
NHRL-10-G-04
NHRL-12-G-03
NHRL-12-G-04

Złącze obrotowe kątowe

- gwint stożkowy z uszczelnieniem teflonowym

NRL



ØD - T
NRL-04-M5
NRL-04-M6
NRL-04-01
NRL-06-M6
NRL-06-01
NRL-06-02

ØD - T
NRL-08-01
NRL-08-02
NRL-08-03
NRL-10-03
NRL-10-04
NRL-12-03
NRL-12-04

Złącze obrotowe kątowe

- gwint walcowy z uszczelką NBR (O-ring)

NRL-G



ØD - T
NRL-04-G-01
NRL-06-G-01
NRL-06-G-02
NRL-08-G-01
NRL-08-G-02
NRL-08-G-03

ØD - T
NRL-10-G-03
NRL-10-G-04
NRL-12-G-03
NRL-12-G-04

Kolektory przyłączeniowe

Symbolika

MODEL – PRZEWÓD – PRZYŁĄCZE

Przewód [ØD]

04	06	08	10	12
Ø4	Ø6	Ø8	Ø10	Ø12

Przyłącze [T]

M5	M6	01	02	03	04
M5 x 0.8	M6 x 1.0	1/8	1/4	3/8	1/2

08	12	14	18
M8 x 1.0	M12 x 1.0	M14 x 1.0	M18 x 1.0

Medium	powietrze (nie stosować z innymi gazami czy cieczami)
Ciśnienie robocze	0 ~ 9 bar
Podciśnienie	-0,95 bar
Zakres temperatur	0-60° C
Możliwe przewody do zastosowania	Poliuretan (PUH) i Poliamid (PA)

Właściwości

- umożliwiają w prosty sposób budowę zespołów i bloków przyłączeniowych
- bloki zaworowe zapewniają porównywalną wielkość przepływu do stalowych połączeń rurowych

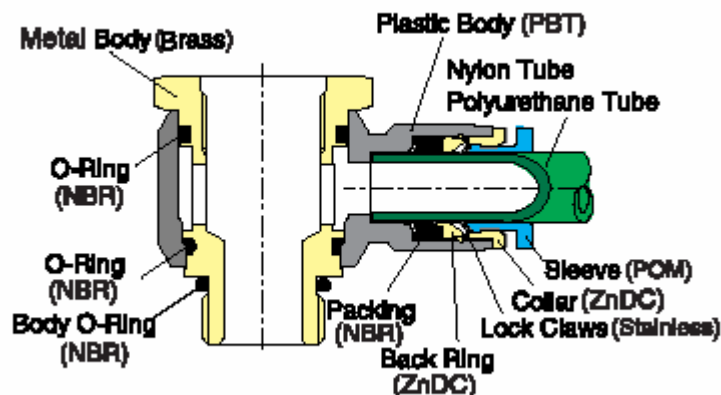

Kolektor przyłączeniowy

- kolektor przyłączeniowy kątowy

BHF



T - ØD
BHF-08-04
BHF-08-06
BHF-12-06
BHF-12-08
BHF-14-08
BHF-14-10
BHF-14-12
BHF-18-12

Kolektor przyłączeniowy

- kolektor przyłączeniowy prosty

BMF



T - ØD
BMF-04-08
BMF-06-08
BMF-06-12
BMF-08-12
BMF-08-14

T - ØD
BMF-10-12
BMF-10-14
BMF-12-14
BMF-12-18

Korek zaślepiający

- gwint walcowy z uszczelką NBR

BPM



T
BPM-08
BPM-12
BPM-14
BPM-18

Kolektor przyłączeniowy

- kolektor przyłączeniowy kątowy

BHM



T ₁ - T ₂
BHM-12-08
BHM-14-12
BHM-14-14
BHM-18-14

Kolektor przyłączeniowy

- gwint stożkowy z uszczelnieniem teflonowym

BL

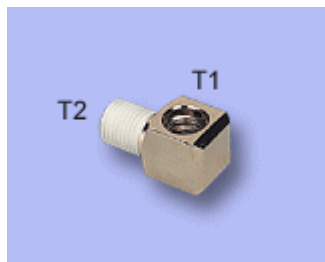

ØD - T

BL-08-01

BL-12-01

BL-12-02

BL-14-02

BL-14-03

BL-14-04

BL-18-03

BL-18-04

Redukcja

- gwint walcowy z uszczelką NBR (O-ring)

BMM



T₁ - T₂

BMM-12-08

BMM-14-12

BMM-18-14

Łącznik prosty (nypel)

- gwint walcowy z uszczelką NBR (O-ring)

BUMM



T

BUMM-08-08

BUMM-12-12

BUMM-14-14

BUMM-18-18

Tłumiki

Symbolika

MODEL – PRZYŁĄCZE



Model	ST-01	ST-02	ST-03	ST-04	STM-02	STM-03
Przyłącze	1/8	1/4	3/8	1/2	1/4	3/8
Maksymalne ciśnienie robocze	7 bar			9 bar	7 bar	

ST – standard

STM - z bloków i płyt przyłączeniowych

Właściwości

- zbudowany z plastiku, bardzo lekki i mocny
- zwarta obudowa pozwala zainstalować w ograniczonej przestrzeni
- stosowany do stłumienia hałasu zwalnianego powietrza, montowany przy otworach wylotowych maszyny

Tłumik plastikowy								
ST	STM							
								
T	<table border="1"><tr><td>T</td></tr><tr><td>ST-01 (BK)</td></tr><tr><td>ST-02 (BK)</td></tr><tr><td>ST-03 (BK)</td></tr><tr><td>ST-04 (BK)</td></tr><tr><td>STM-02 (BK)</td></tr><tr><td>STM-03 (BK)</td></tr></table>	T	ST-01 (BK)	ST-02 (BK)	ST-03 (BK)	ST-04 (BK)	STM-02 (BK)	STM-03 (BK)
T								
ST-01 (BK)								
ST-02 (BK)								
ST-03 (BK)								
ST-04 (BK)								
STM-02 (BK)								
STM-03 (BK)								

Przewody zwykłe i spiralne [PUH]

Symbolika przewodu

MODEL – ŚREDNICA ZEWNĘTRZNA – ŚREDNICA WEWNĘTRZNA - KOLOR

U – Przewód Poliuretanowy PUH

Symbolika sprężyn

MODEL – ŚR. ZEWNĘTRZNA – ŚR. WEWNĘTRZNA - DŁUGOŚĆ [M] - KOLOR

UC – Sprężyna Poliuretanowa PUH

Medium	powietrze (nie stosować z innymi gazami czy cieczami)
Ciśnienie robocze	0 ~ 9 bar
Podciśnienie	-0,95 bar
Zakres temperatur	-15 ~ 60° C
Możliwe przewody do zastosowania	Poliuretan (PUH) i Poliamid (PA)

Średnice przewodu

	0420	0640	0806	1209
Średnica zewnętrzna	Ø4	Ø6	Ø8	Ø12
Średnica wewnętrzna	Ø2	Ø4	Ø6	Ø9

Kolor

C	BK	BU	R	G	Y
Naturalny	Czarny	Niebieski	Czerwony	Zielony	Żółty

Właściwości

- większa elastyczność w stosunku do przewodów poliamidowych ułatwia rozprowadzanie przewodów w małej przestrzeni
- elastyczność zostaje zachowana przy niskich temperaturach

Przewód poliuretanowy

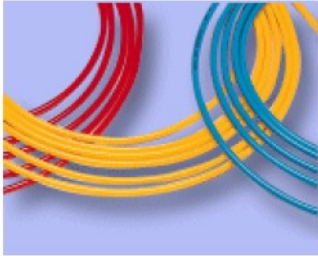
<p>U</p> 	<table border="1" style="width: 100%; border-collapse: collapse;"> <thead> <tr> <th style="text-align: center;">Ø - Ø</th> </tr> </thead> <tbody> <tr><td style="text-align: center;">U-03020-BK</td></tr> <tr><td style="text-align: center;">U-03020-BU</td></tr> <tr><td style="text-align: center;">U-04020-BK</td></tr> <tr><td style="text-align: center;">U-04020-C</td></tr> <tr><td style="text-align: center;">U-04020-BU</td></tr> <tr><td style="text-align: center;">U-04020-R</td></tr> <tr><td style="text-align: center;">U-04020-G</td></tr> <tr><td style="text-align: center;">U-06040-BK</td></tr> <tr><td style="text-align: center;">U-06040-C</td></tr> <tr><td style="text-align: center;">U-06040-BU</td></tr> <tr><td style="text-align: center;">U-06040-R</td></tr> <tr><td style="text-align: center;">U-06040-G</td></tr> </tbody> </table>	Ø - Ø	U-03020-BK	U-03020-BU	U-04020-BK	U-04020-C	U-04020-BU	U-04020-R	U-04020-G	U-06040-BK	U-06040-C	U-06040-BU	U-06040-R	U-06040-G	<table border="1" style="width: 100%; border-collapse: collapse;"> <thead> <tr> <th style="text-align: center;">Ø - Ø</th> </tr> </thead> <tbody> <tr><td style="text-align: center;">U-08055-BK</td></tr> <tr><td style="text-align: center;">U-08055-C</td></tr> <tr><td style="text-align: center;">U-08055-BU</td></tr> <tr><td style="text-align: center;">U-08055-R</td></tr> <tr><td style="text-align: center;">U-08055-G</td></tr> <tr><td style="text-align: center;">U-10065-BU</td></tr> <tr><td style="text-align: center;">U-10065-BK</td></tr> <tr><td style="text-align: center;">U-12090-BK</td></tr> <tr><td style="text-align: center;">U-12090-C</td></tr> <tr><td style="text-align: center;">U-12090-BU</td></tr> <tr><td style="text-align: center;">U-12090-R</td></tr> <tr><td style="text-align: center;">U-12090-G</td></tr> </tbody> </table>	Ø - Ø	U-08055-BK	U-08055-C	U-08055-BU	U-08055-R	U-08055-G	U-10065-BU	U-10065-BK	U-12090-BK	U-12090-C	U-12090-BU	U-12090-R	U-12090-G
Ø - Ø																												
U-03020-BK																												
U-03020-BU																												
U-04020-BK																												
U-04020-C																												
U-04020-BU																												
U-04020-R																												
U-04020-G																												
U-06040-BK																												
U-06040-C																												
U-06040-BU																												
U-06040-R																												
U-06040-G																												
Ø - Ø																												
U-08055-BK																												
U-08055-C																												
U-08055-BU																												
U-08055-R																												
U-08055-G																												
U-10065-BU																												
U-10065-BK																												
U-12090-BK																												
U-12090-C																												
U-12090-BU																												
U-12090-R																												
U-12090-G																												

Przewód spiralny poliuretanowy

<p>UC</p> 	<table border="1" style="width: 100%; border-collapse: collapse;"> <thead> <tr> <th style="text-align: center;">Ø - Ø - L</th> </tr> </thead> <tbody> <tr><td style="text-align: center;">UC-0402-15-BU</td></tr> <tr><td style="text-align: center;">UC-0402-15-BK</td></tr> <tr><td style="text-align: center;">UC-0402-15-R</td></tr> <tr><td style="text-align: center;">UC-0402-15-G</td></tr> <tr><td style="text-align: center;">UC-0402-15-Y</td></tr> <tr><td style="text-align: center;">UC-0402-30-BU</td></tr> <tr><td style="text-align: center;">UC-0402-30-BK</td></tr> <tr><td style="text-align: center;">UC-0402-30-R</td></tr> <tr><td style="text-align: center;">UC-0402-30-G</td></tr> <tr><td style="text-align: center;">UC-0402-30-Y</td></tr> <tr><td style="text-align: center;">UC-0402-45-BU</td></tr> <tr><td style="text-align: center;">UC-0402-45-BK</td></tr> <tr><td style="text-align: center;">UC-0402-45-R</td></tr> <tr><td style="text-align: center;">UC-0402-45-G</td></tr> <tr><td style="text-align: center;">UC-0402-45-Y</td></tr> <tr><td style="text-align: center;">UC-0402-75-BU</td></tr> <tr><td style="text-align: center;">UC-0402-75-BK</td></tr> <tr><td style="text-align: center;">UC-0402-100-BU</td></tr> <tr><td style="text-align: center;">UC-0402-100-BK</td></tr> </tbody> </table>	Ø - Ø - L	UC-0402-15-BU	UC-0402-15-BK	UC-0402-15-R	UC-0402-15-G	UC-0402-15-Y	UC-0402-30-BU	UC-0402-30-BK	UC-0402-30-R	UC-0402-30-G	UC-0402-30-Y	UC-0402-45-BU	UC-0402-45-BK	UC-0402-45-R	UC-0402-45-G	UC-0402-45-Y	UC-0402-75-BU	UC-0402-75-BK	UC-0402-100-BU	UC-0402-100-BK	<table border="1" style="width: 100%; border-collapse: collapse;"> <thead> <tr> <th style="text-align: center;">Ø - Ø - L</th> </tr> </thead> <tbody> <tr><td style="text-align: center;">UC-0604-15-BU</td></tr> <tr><td style="text-align: center;">UC-0604-15-BK</td></tr> <tr><td style="text-align: center;">UC-0604-15-R</td></tr> <tr><td style="text-align: center;">UC-0604-15-G</td></tr> <tr><td style="text-align: center;">UC-0604-15-Y</td></tr> <tr><td style="text-align: center;">UC-0604-30-BU</td></tr> <tr><td style="text-align: center;">UC-0604-30-BK</td></tr> <tr><td style="text-align: center;">UC-0604-30-R</td></tr> <tr><td style="text-align: center;">UC-0604-30-G</td></tr> <tr><td style="text-align: center;">UC-0604-30-Y</td></tr> <tr><td style="text-align: center;">UC-0604-45-BU</td></tr> <tr><td style="text-align: center;">UC-0604-45-BK</td></tr> <tr><td style="text-align: center;">UC-0604-45-R</td></tr> <tr><td style="text-align: center;">UC-0604-45-G</td></tr> <tr><td style="text-align: center;">UC-0604-45-Y</td></tr> <tr><td style="text-align: center;">UC-0604-75-BU</td></tr> <tr><td style="text-align: center;">UC-0604-75-BK</td></tr> <tr><td style="text-align: center;">UC-0604-100-BU</td></tr> <tr><td style="text-align: center;">UC-0604-100-BU</td></tr> </tbody> </table>	Ø - Ø - L	UC-0604-15-BU	UC-0604-15-BK	UC-0604-15-R	UC-0604-15-G	UC-0604-15-Y	UC-0604-30-BU	UC-0604-30-BK	UC-0604-30-R	UC-0604-30-G	UC-0604-30-Y	UC-0604-45-BU	UC-0604-45-BK	UC-0604-45-R	UC-0604-45-G	UC-0604-45-Y	UC-0604-75-BU	UC-0604-75-BK	UC-0604-100-BU	UC-0604-100-BU
Ø - Ø - L																																										
UC-0402-15-BU																																										
UC-0402-15-BK																																										
UC-0402-15-R																																										
UC-0402-15-G																																										
UC-0402-15-Y																																										
UC-0402-30-BU																																										
UC-0402-30-BK																																										
UC-0402-30-R																																										
UC-0402-30-G																																										
UC-0402-30-Y																																										
UC-0402-45-BU																																										
UC-0402-45-BK																																										
UC-0402-45-R																																										
UC-0402-45-G																																										
UC-0402-45-Y																																										
UC-0402-75-BU																																										
UC-0402-75-BK																																										
UC-0402-100-BU																																										
UC-0402-100-BK																																										
Ø - Ø - L																																										
UC-0604-15-BU																																										
UC-0604-15-BK																																										
UC-0604-15-R																																										
UC-0604-15-G																																										
UC-0604-15-Y																																										
UC-0604-30-BU																																										
UC-0604-30-BK																																										
UC-0604-30-R																																										
UC-0604-30-G																																										
UC-0604-30-Y																																										
UC-0604-45-BU																																										
UC-0604-45-BK																																										
UC-0604-45-R																																										
UC-0604-45-G																																										
UC-0604-45-Y																																										
UC-0604-75-BU																																										
UC-0604-75-BK																																										
UC-0604-100-BU																																										
UC-0604-100-BU																																										

P.P.H.U. Trans-West GmbH Sp. z o. o.

ul. Prądyńskiego 20, 63-000 Środa Wielkopolska

tel. (0-61) 287-02-64, tel/fax (0-61) 285-26-63

e-mail: transwest@telvnet.pl www.transwest.pl